

KOBELCO

SK380XDL_{LC}

■ **Bucket Capacity :**

1.6 – 1.9 m³ (ISO heaped)

■ **Engine Power :**

191 kW/2,100 min⁻¹

■ **Operating Weight :**

38,300 kg



We Save You Fuel
Achieving a Low-Carbon Society

Power Meets Efficiency

In line with KOBELCO's concept of earth-friendly construction machinery that will work long and hard on any site on the planet, the rugged machine body is newly designed, and comprehensive reinforcement makes the attachment more robust.

It all adds up to KOBELCO's toughest ever mining excavator.

The latest hydraulics technology delivers both high-powered output and lower fuel consumption.

As the 10th generation model of KOBELCO's SK series, the SK380XDL meets the needs of the most punishing mining sites with a performance that simply astounds.





Increase in
productivity
means
"Power"

24%*
Higher fuel
saving means
"Efficiency"

*Compared to S-mode on the SK330-8.

Even Stronger Attachment

Reinforced Arm Exhibits Strength

Thick steel plate **NEW**



Arm top

Thickness of steel plate has been increased in preference to adding reinforcing plates.



Arm foot

Base plate thickness has been increased.

Modified Foot Boss Shape **NEW**



The arm foot boss shape has been modified and improved to distribute stress, delivering more strength for tasks like digging next to a wall.



Rock Guards

Specially designed long, solid rock guard installed to prevent damage to arm.





Increase in productivity means "Power"

The boom and arm that take the greatest punishment are significantly reinforced.

Newly Developed Mining Boom Made of Thicker Steel Plate

Featuring an XD Boom NEW

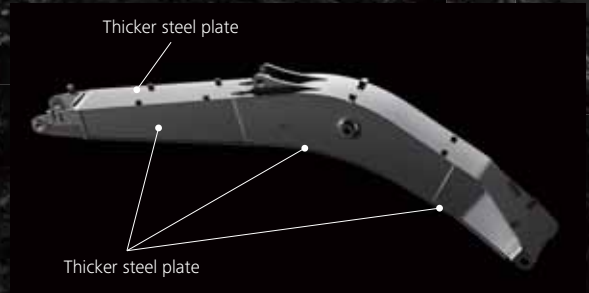

The XD boom features stronger plates compared to the HD booms of standard machines, which increases longevity even under the toughest working conditions.

Big Cross-Section Boom NEW



Newly designed, big cross-section boom for unbeatable durability under harsh working conditions.

Side Deck Bumpers and Protective Guards that Cover the Main Upper Machinery

Side Deck Bumpers

Side deck bumpers are fitted to protect power plant and cab.



Upper Under Covers

Thick covers with increased durability compared to standard models.



Increase in Productivity Means "Power"

Powerful travel system for easy transit over loose stones, and highly reliable filtration system ensure higher machine performance.

Crawlers Built for Unbeatable Durability

Reinforced Guide Frame



Reinforced guide frame prevents deformation caused by impact or encroaching of loose stones.

Reinforced Step



Design of the step uses strong, thick-plate steel, to stop large rocks impacting the travel motor.

Track Guides



Large, reinforced track guides are installed in three locations.

Double-Support Outer Flange Upper Rollers



Thicker Steel Plate for Shoes



Reinforced HD shoes of thick steel plate to master rough, stony ground.

Track Links



The size and durability of the track link are increased compared to standard models.

Reinforced Travel Motor Cover



Rear of travel motor cover is reinforced.

Lower Frame Underside Cover



Hydraulic piping and equipment protected against damage from rubble and stony ground.



Improved Filtration System Reliability

Clean, contaminant-free fuel and hydraulic fluid are essential to stable performance.

The improved filtration systems reduce the risk of mechanical trouble and enhance longevity and durability.

Fuel Filter **NEW**

The pre-filter with built-in water separator has 1.8 times more filter area compared to the previous models and with a new final stage maintenance free fuel filter to maximize filtering performance.

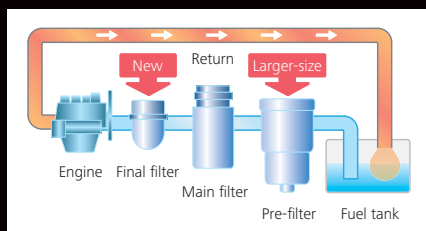

Hydraulic Fluid Filter **NEW**

Recognized as the best in the industry, our Premium-fine filter separates out even the smallest particles. New cover prevents contamination when changing filters.

Metal Mesh Cover Air Cleaner **NEW**

Metal mesh cover ensures strength and durability.

Hydraulic Fluid Filter Clog Detector **NEW**

Hydraulic tank pressure sensor monitors the pressure difference between the return line and tank inside pressure to determine the degree of clogging. If the difference exceeds a predetermined level, a warning appears on the multi-display, so any contamination can be trapped by the filter and replaced before it reaches the hydraulic fluid in the tank.

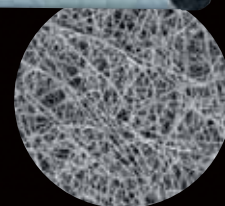
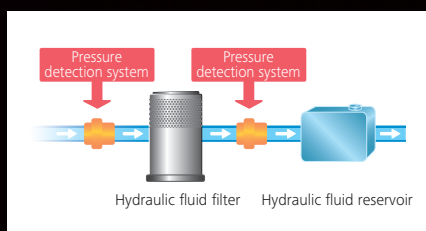

Enlarged filter image

Evolution Continues, with Improved Fuel Efficiency

24%*
Higher fuel saving means
"Efficiency"

The new arm interflow system more efficiently controls hydraulic fluid flow, and significant reduction of in-line resistance and pressure loss boosts fuel efficiency by about 24%*.

*in Eco-mode compared to S-mode on the SK330-8.

Hydraulic System: Revolutionary Technology Saves Fuel

Arm Interflow System NEW

When lowering the boom, this system uses the downward force generated by the boom's weight to push fluid to the shovel arm. This greatly reduces the need to apply power from outside the system.

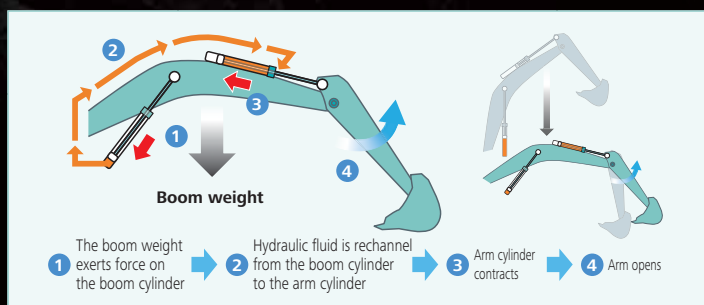

Energy Saving System Saves Fuel Further

Fuel efficient work mode ECO-mode NEW

The fuel-saving ECO-mode is newly provided to the work mode, selectable according to a desired operation. Fuel consumption can be greatly reduced.



- E** Used to reduce fuel consumption for small workloads
ECO-mode, 24% decrease
(compared to S-mode on the SK330-8.)
- H** Used to prioritize the amount of work done
H-mode, 16% decrease
(compared to H-mode on the SK330-8.)
- S** Used to strike a balance between workloads and fuel efficiency
S-mode, 19% decrease
(compared to S-mode on the SK330-8.)



Get More Done Faster

Standard 3.30 m arm (reinforced for rocks)

■ Max. Bucket Digging Force
Normal: **229 kN**
With power boost: **252 kN**

■ Max. Arm Crowding Force
Normal: **165 kN**
With power boost: **182 kN**

■ Max. Digging Reach: **11,260 mm**

■ Max. Digging Depth: **7,560 mm**

■ Max. Vertical Digging Depth: **6,480 mm**

Piping for Breaker

Piping for breaker is fitted as standard.



Top Class Traveling Force

Powerful traveling force and drawbar pulling force deliver plenty of speed when climbing slopes or negotiating bad roads, and the agility to change direction swiftly and smoothly.

■ Drawbar Pulling Force: **320 kN**

Comfortable Cab Is Now Safer than Ever

A work environment that is quieter and more comfortable. A cab that puts the operator first is key to improved safety.



Large Cab **NEW**

4% larger than the previous cab capacity. Relaxing environment allows work to be performed in comfort.

Air Conditioner **NEW** Louvers behind the Seat

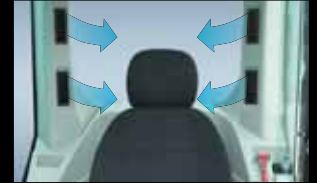

The large air-conditioner has louvers on the back pillars that blow from behind and to the right and left of the operator's seat. They can be adjusted to put a direct flow of cool/warm air on the operator, which means a more comfortable operating environment.

Super-Airtight Cab **NEW**



The high level of air-tightness keeps dust out of the cab.

Low Vibration **NEW**

Coil springs absorb small vibrations, and high suspension mounts filled with silicone oil reduce heavy vibration. The long stroke achieved by this system provides excellent protection from vibration.

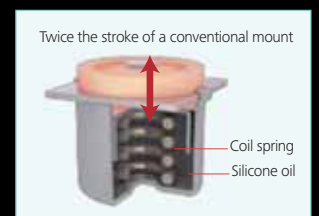

Multi-Display in Color **NEW**

Brilliant colors and graphic displays are easy to recognize on the LCD multi-display in the console. The display shows fuel consumption, maintenance intervals, and more.



- 1 Analog gauge provides an intuitive reading of fuel level and engine water temperature
- 2 Green indicator light shows low fuel consumption during operation
- 3 Fuel consumption/Switch indicator for rear camera images
- 4 Digging mode switch
- 5 Monitor display switch

One-Touch Attachment Mode Switch

A simple touch of a button, switches the hydraulic circuit and flow amount to match attachment changes. Icons help the operator to confirm the proper configuration at a glance.

Comfort



Broad View ^{NEW} Liberates the Operator

The front window features one large piece of glass without a center pillar on the right side for a wide, unobstructed view.

Large Cab Is Easy ^{NEW} to Get In and Out of

The expanded cab provides plenty of room for a large door, more headroom and smoother entry and exit.



+ 80 mm

More Comfortable Seat Means Higher Productivity



Vibration absorbing suspension seat



Seat recliner can be pushed back flat



Double slides allow adjustment for optimum comfort

A Light Touch on the ^{NEW} Lever Means Smoother, Less Tiring Work



38%
Less

It takes 38% less effort to work the operation lever, which reduces fatigue over long working hours or continued operations.

Interior Equipment Adds to Comfort and Convenience



12 V outlet

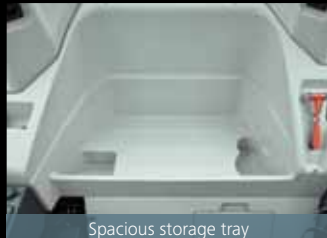

Spacious storage tray



Large cup holder

Safety

ROPS Cab ^{NEW}

ROPS (Roll-Over-Protective Structure)-compliant cab clears ISO standards (ISO-12117-2: 2008) and ensures greater safety for the operator should the machine tip over.



Improved Operational ^{NEW} Safety Cab Guard (Optional)



The top guard (FOPS, Top Guard Level II. (Meets ISO10262)) provided as standard. The top-mounted working light ensures a wide field of view.

Wide View During Operations High Visibility for Safety



Greater safety assured by rearview mirrors on left and right.



Hammer for emergency exit

Efficient Maintenance Keeps the Machine in Peak Operating Condition



Examples of displaying maintenance information

Machine Information Display Function

- Displays only the maintenance information that's needed, when it's needed
- Self-diagnostic function provides early-warning detection and display of electrical system malfunctions
- Service-diagnostic function makes it easier to check the status of the machine
- Record function of previous breakdowns including irregular and transient malfunction

Easy, On-the-Spot Maintenance

There is ample space in the engine compartment for a mechanic to do maintenance work inside. The distance between steps is lower so entry and exit is easier. And the mechanic can work in comfort, without contortions or unnatural body positions. Finally, the hood is lighter and easier to raise and lower.



Generous space for maintenance work



Step/Hand rail

Maintenance Work, Daily Checks, Etc., Can Be Done from Ground Level

The layout allows for easy access from the ground for many daily checks and regular maintenance tasks.



Double-element air cleaner

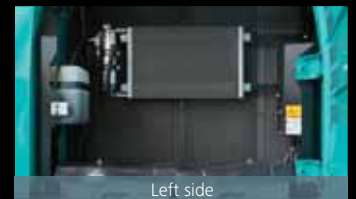

Left side

Simple layout for easy access to radiator and cooling system elements.

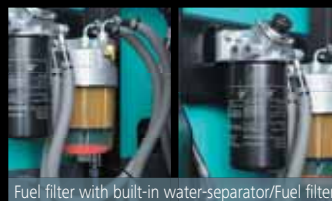

Fuel filter with built-in water-separator/Fuel filter

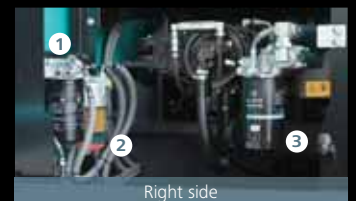

Right side

- 1 Fuel filter
- 2 Fuel filter with built-in water-separator
- 3 Engine oil filter

Easy Cleaning



Crawler frame

Special crawler frame design for easy mud removal cleaning.



Detachable two-piece floor mat

Detachable two-piece floor mat with handles for easy removal. A floor drain is located under floor mat.



Floor mat with raised edges

Floor mat's raised edges help keep the cab floor free of mud, simplify cleaning.



Engine oil pan

Engine oil pan equipped with drain valve.

More Efficient Maintenance inside the Cab

Internal and external air conditioner filters can be easily removed without tools for cleaning.



Air conditioner filters

KOMEXS

KOMEXS is the remote monitoring system for SK series excavators. When a hydraulic excavator is fitted with this system, data on the machine's operation, such as operating hours, location, fuel consumption, and maintenance status can be obtained remotely.



Specifications



Engine

Model	HINO J08E-UN
Type	Direct injection, water-cooled, 4-cycle, 6-cylinder diesel engine with intercooler turbo-charger
No. of cylinders	6
Bore and stroke	112 mm X 130 mm
Displacement	7.684 L
Rated power output	191 kW/2,100 min ⁻¹ (with fan)
	200 kW/2,100 min ⁻¹ (ISO 9249: without fan)
Max. torque	979 N•m/1,600 min ⁻¹ (with fan)
	998 N•m/1,600 min ⁻¹ (ISO 9249: without fan)



Hydraulic System

Pump	
Type	Two variable displacement piston pumps + one gear pump
Max. discharge flow	2 x 294 L/min, 1 x 21 L/min
Relief valve setting	
Boom, arm and bucket	34.3 MPa {350 kgf/cm ² }
Power Boost	37.8 MPa {385 kgf/cm ² }
Travel circuit	34.3 MPa {350 kgf/cm ² }
Swing circuit	29.0 MPa {296 kgf/cm ² }
Control circuit	5.0 MPa {50 kgf/cm ² }
Pilot control pump	Gear type
Main control valves	8-spool
Oil cooler	Air cooled type



Swing System

Swing motor	Axial-piston motor
Brake	Hydraulic; locking automatically when the swing control lever is in neutral position
Parking brake	Wet multiple plate
Swing speed	10.2 min ⁻¹ {rpm}



Attachments

Backhoe bucket and arm combination (reference only)

Use	Backhoe bucket			
		Normal digging		
Bucket capacity	ISO heaped	m ³	1.9	1.6
	ISO struck	m ³	1.45	1.2
Opening width	With side cutters	mm	1,740	1,470
	Without side cutters	mm	1,740	1,470
No. of bucket teeth			5	5
Bucket weight		kg	2,070	1,570
Combinations	Short 2.60 m arm		○	–
	Long 3.30 m arm		–	○

○ Recommended



Travel System

Travel motors	Variable displacement piston pump
Travel brakes	Hydraulic
Parking brakes	Wet multiple plate
Travel shoes	48 each side
Travel speed	5.6/3.3 km/h
Drawbar pulling force	320 kN (SAE)
Gradeability	70% {35°}



Cab & Control

Cab	All-weather, sound-suppressed steel cab mounted on the high suspension mounts filled with silicone oil and equipped with a heavy, insulated floor mat.
Control	Two hand levers and two foot pedals for travel Two hand levers for excavating and swing Electric rotary-type engine throttle



Boom, Arm & Bucket

Boom cylinders	140 mm x 1,550 mm
Arm cylinder	170 mm x 1,788 mm
Bucket cylinder	150 mm x 1,193 mm



Refilling Capacities & Lubrications

Fuel tank	503 L
Cooling system	35 L
Engine oil	26.0 L
Travel reduction gear	2 x 8.0 L
Swing reduction gear	7.4 L
Hydraulic oil tank	245 L tank oil level
	407 L hydraulic system

Specifications



Working Ranges

Unit: m

Boom	6.50 m	
	Arm	
Range	Short 2.60 m	Standard 3.30 m
a- Max. digging reach	10.61	11.26
b- Max. digging reach at ground level	10.40	11.06
c- Max. digging depth	6.84	7.56
d- Max. digging height	10.23	10.54
e- Max. dumping clearance	7.07	7.37
f- Min. dumping clearance	3.34	2.62
g- Max. vertical wall digging depth	5.70	6.48
h- Min. swing radius	4.46	4.31
i- Horizontal digging stroke at ground level	4.21	5.82
j- Digging depth for 2.4 m (8') flat bottom	6.65	7.40
Bucket capacity ISO heaped m ³	1.90	1.60

Digging Force (ISO 6015)

Unit: kN

Arm length	Short 2.60 m	Standard 3.30 m
Bucket digging force	229 252*	
Arm crowding force	207 228*	165 182*

*Power Boost engaged.

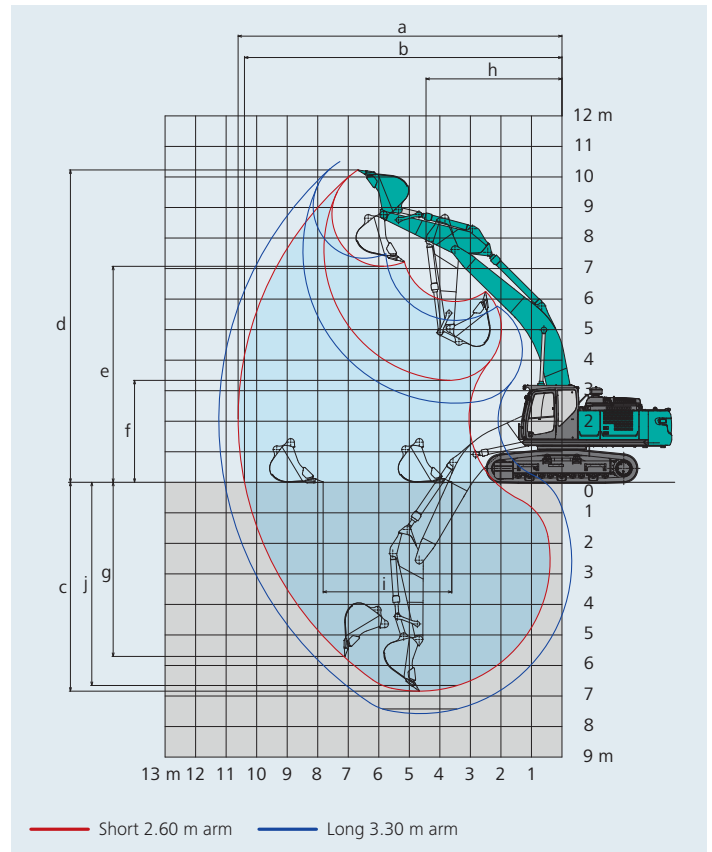

Dimensions

Arm length	Short 2.60 m	Standard 3.30 m
A Overall length	11,380	11,290
B Overall height (to top of boom)	3,690	3,410
C Overall width	3,260	
D Overall height (to top of cab)	3,170	
E Ground clearance of rear end*	1,210	
F Ground clearance*	515	

	Unit: mm
G Tail swing radius	3,600
G' Distance from center of swing to rear end	3,600
H Tumbler distance	4,050
I Overall length of crawler	4,970
J Track gauge	2,590
K Shoe width	600
L Overall width of upperstructure	3,120

*Without including height of shoe.

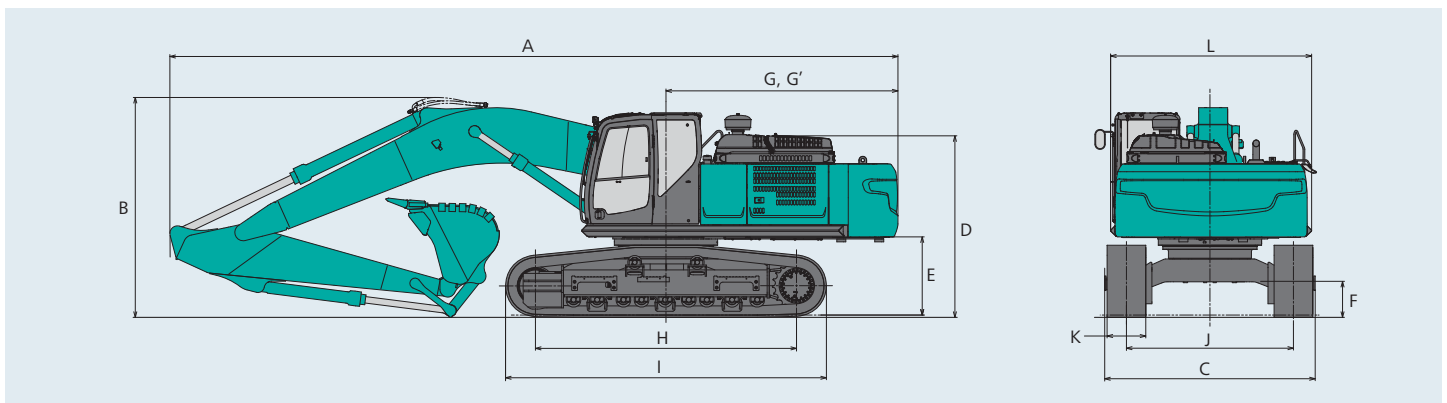

Operating Weight & Ground Pressure

In standard trim, with standard boom, 3.30 m arm, and 1.60 m³ ISO heaped bucket

Shaped		Triple grouser shoes (even height)
Shoe width	mm	600
Overall width	mm	3,260
Ground pressure	kPa	72
Operating weight	kg	38,300

Lift Capacities

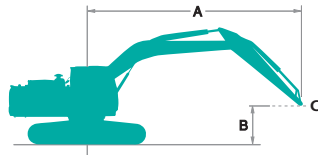

Rating over front



Rating over side or 360 degrees

A: Reach from swing centerline to arm top
 B: Arm top height above/below ground
 C: Lift point

Relief valve setting: 34.3 MPa (350 kgf/cm²)

SK380XDLC		Short arm: 2.60 m Bucket: without Counterweight: 8,590 kg Shoe: 600 mm HD										
B \ A		3.0 m		4.5 m		6.0 m		7.5 m		At Max. Reach		Radius
7.5 m	kg									*7,820	*7,820	7.06 m
6.0 m	kg					*8,360	*8,360	*7,670	*7,670	*7,600	7,050	8.00 m
4.5 m	kg			*12,020	*12,020	*9,330	*9,330	*8,030	7,640	*7,570	6,180	8.58 m
3.0 m	kg					*10,480	10,030	*8,580	7,330	*7,640	5,730	8.87 m
1.5 m	kg					*11,380	9,530	*9,060	7,060	*7,760	5,580	8.89 m
G.L.	kg			*15,850	13,890	*11,760	9,260	*9,280	6,880	*7,920	5,710	8.66 m
-1.5 m	kg			*15,040	13,940	*11,490	9,200	*9,020	6,850	*8,050	6,190	8.15 m
-3.0 m	kg	*16,970	*16,970	*13,400	*13,400	*10,390	9,330			*8,060	7,270	7.29 m
-4.5 m	kg	*12,820	*12,820	*10,360	*10,360					*7,570	*7,570	5.95 m

SK380XDLC		Short arm: 3.30 m Bucket: without Counterweight: 8,590 kg Shoe: 600 mm HD														
B \ A		1.5 m		3.0 m		4.5 m		6.0 m		7.5 m		9.0 m		At Max. Reach		Radius
9.0 m	kg													*5,700	*5,700	6.58 m
7.5 m	kg									*6,870	*6,870			*5,220	*5,220	7.88 m
6.0 m	kg									*6,980	*6,980			*5,040	*5,040	8.72 m
4.5 m	kg					*10,740	*10,740	*8,590	*8,590	*7,460	*7,460	*6,880	5,720	*5,050	*5,050	9.25 m
3.0 m	kg					*13,360	*13,360	*9,840	*9,840	*8,110	7,340	*7,140	5,570	*5,220	5,090	9.52 m
1.5 m	kg					*15,270	14,230	*10,940	9,550	*8,730	7,020	*7,420	5,410	*5,550	4,960	9.54 m
G.L.	kg					*15,900	13,760	*11,570	9,180	*9,120	6,790	*7,540	5,300	*6,130	5,050	9.32 m
-1.5 m	kg			*14,010	*14,010	*15,550	13,670	*11,610	9,030	*9,120	6,680			*7,090	5,400	8.84 m
-3.0 m	kg	*15,940	*15,940	*19,520	*19,520	*14,350	13,810	*10,930	9,070	*8,450	6,730			*7,530	6,170	8.06 m
-4.5 m	kg			*15,830	*15,830	*12,010	*12,010	*9,110	*9,110					*7,420	*7,420	6.86 m

Notes:

- Do not attempt to lift or hold any load that is greater than these lift capacities at their specified lift point radius and heights. Weight of all accessories must be deducted from the above lift capacities.
- Lift capacities are based on machine standing on level, firm, and uniform ground. User must make allowance for job conditions such as soft or uneven ground, out of level conditions, side loads, sudden stopping of loads, hazardous conditions, experience of personnel, etc.
- Arm top pin is defined as lift point.
- The above lift capacities are in compliance with ISO 10567. They do not exceed 87% of hydraulic lift capacity or 75% of tipping load. Lift capacities marked with an asterisk (*) are limited by hydraulic capacity rather than tipping load.
- Operator should be fully acquainted with the Operator's and Maintenance Instructions before operating this machine. Rules for safe operation of equipment should be adhered to at all times.
- Lift capacities apply to only machine as originally manufactured and normally equipped by KOBELCO CONSTRUCTION MACHINERY CO., LTD.

STANDARD EQUIPMENT

ENGINE

- Engine, HINO J08E-UN, diesel engine with turbocharger and intercooler
- Automatic engine deceleration
- Auto Idle Stop (AIS)
- Batteries (2 x 12 V - 96 Ah)
- Starting motor (24 V - 5 kW), 60 amp alternator
- Automatic engine shut-down for low engine oil pressure
- Engine oil pan drain cock
- Double element air cleaner

CONTROL

- Working mode selector (H-mode, S-mode and ECO-mode)
- Power Boost

SWING SYSTEM & TRAVEL SYSTEM

- Swing rebound prevention system
- Straight propel system
- Two-speed travel with automatic shift down
- Sealed & lubricated track links
- Grease-type track adjusters
- 600 mm HD triple grouser shoe
- Automatic swing brake
- Tow eyes
- Travel alarm
- Lower under cover

HYDRAULIC

- Arm interflow system
- Auto warm up system

- Aluminum hydraulic oil cooler
- Hydraulic fluid filter clog detector
- N&B piping

MIRRORS & LIGHTS

- Two rear view mirrors
- Five front working lights (Two for boom, one for right storage box and two for cab)

CAB & CONTROL

- Two control levers, pilot-operated
- Horn, electric
- Cab light (interior)
- Luggage tray
- Large cup holder
- Detachable two-piece floor mat
- Headrest
- Handrails
- Intermittent windshield wiper with double-spray washer
- Tinted safety glass
- Pull-up type front window and removable lower front window
- Easy-to-read multi-display color monitor
- Automatic air conditioner
- Emergency escape hammer
- Excavator Remote Monitoring System
- Suspension seat
- 12 V outlet

OPTIONAL EQUIPMENT

- Rear view camera
- Refilling pump
- Cab guards
- Top guard
- Rotatory beacon
- Rear camera
- Air suspension seat
- Refilling pump

Note: Standard and optional equipment may vary. Consult your KOBELCO dealer for specifics.

EXCAVATOR REMOTE MONITORING SYSTEM

Remote Monitoring System is a satellite-based system for receiving machine information. Manage your machines anywhere in the world using the Internet. Location, workload and diagnostic data aid business operations.

Direct Access to Operational Status

Location Data

Accurate location data can be obtained even from sites where communications are difficult.

Operating Hours

A comparison of operating times of machines at multiple locations shows which locations are busier and more profitable.

Operating hours on site can be accurately recorded, for running time calculations needed for rental machines, etc.

Fuel Consumption Data

Data on fuel consumption and idling times can be used to indicate improvements in fuel consumption.

Graph of Work Content

The graph shows how working hours are divided among different operating categories, including digging, idling, traveling, and optional operations (N&B).

Note: Remote monitoring system is not applicable in some area due to country regulation of the communication lines or availability of infrastructure.



Maintenance Data and Warning Alerts

Machine Maintenance Data

Provides maintenance status of separate machines operating at multiple sites. Maintenance data is also relayed to KOBELCO service personnel, for more efficient planning of periodic servicing.

Security System

Engine Start Alarm

Sends a notification if the engine is started outside of pre-defined hours.

Area Alarm

Sends a notification if the machine leaves a pre-defined area.

Note: This catalog may contain attachments and optional equipment that are not available in your area. And it may contain photographs of machines with specifications that differ from those of machines sold in your areas. Please consult your nearest KOBELCO distributor for those items you require. Due to our policy of continuous product improvements all designs and specifications are subject to change without advance notice. Copyright by **KOBELCO CONSTRUCTION MACHINERY CO., LTD.** No part of this catalog may be reproduced in any manner without notice.

KOBELCO CONSTRUCTION MACHINERY CO., LTD.

5-15, Kitashinagawa 5-chome, Shinagawa-ku, Tokyo 141-8626 JAPAN
 Tel: +81 (0) 3-5789-2146 Fax: +81 (0) 3-5789-2135
<https://www.kobelcocm-global.com/>

Inquiries To: